

Teldat 4Ge Router

Installation Manual

Copyright© Teldat Dm571-I Version 7.7 07/2022 Teldat S.A.

Legal Notice

Warranty

This publication is subject to change.

Teldat S.A. offers no warranty whatsoever for information contained in this manual.

Teldat S.A. is not liable for any direct, indirect, collateral, consequential or any other damage connected to the delivery, supply or use of this manual.

Table of Contents

I	Related Documents	1
Chapter 1	About This Guide	2
1.1	Supported Devices	2
1.2	Who should read this manual?	2
1.3	When should this manual be read?	2
1.4	What is in this manual?	2
1.5	What is not in this manual?	2
1.6	How is the information organized?	2
1.7	Technical Support	2
Chapter 2	Teldat 4Ge Router	4
2.1	Characteristics	4
2.1.1	Power Supply	4
2.1.2	Hardware Monitoring	4
Chapter 3	Components and Power Supply	5
3.1	Components	5
3.1.1	Front Panel	5
3.1.2	Rear Panel	5
3.1.3	Side Panels	6
3.1.4	Underside Panel	6
3.1.5	Top Panel (LEDs).	7
3.2	Assembly	8
3.2.1	Mounting in rack	8
3.2.2	Standalone	8
3.2.3	Wall mounting	8
3.2.4	Ceiling mounting	10
3.2.5	Installing a DIN rail mount accessory (Optional).	10
3.3	Power Source	11
3.3.1	External Power Source	11
3.3.2	PoE.	12
3.3.3	Connecting to the power source	12
3.3.4	Connect	12
3.3.5	Disconnect.	13
3.4	RESET Button	13
3.4.1	Rebooting the device	13

3.4.2	Default Configuration	13
3.5	Connecting data	14
3.5.1	ETHERNET Connection	14
3.5.2	Connecting the WWAN Antenna	14
3.6	Installing the SIM card.	15
Chapter 4	Compliance	17
4.1	Manufacturer information	17
4.2	Safety Warnings	21
4.3	WEEE Information	21
4.4	REACH	21
4.5	PSU Energy Efficiency	22
4.6	EC Declaration of Conformity.	23
4.7	CE Marking	23
4.8	National Restrictions	23
4.9	Operating Frequency	24
4.10	FCC Statement.	24
4.10.1	Federal Communications Commission Interference	24
4.11	IC Statement.	24
4.11.1	CAN ICES-3 (B)/NMB-3(B).	24
Appendix A	Technical Information	26
A.1	Troubleshooting	26
A.2	Updating the software	26
A.3	Connectors	26
A.3.1	LAN Connector.	27
A.3.2	WWAN Connector (female)	27
A.3.3	Power Supply Connector	27
A.4	Technical Specifications	27
A.4.1	Hardware Architecture.	27
A.4.2	LAN Interface	28
A.4.3	Wireless WAN Interface	28
A.4.4	Power Supply	28
A.4.5	External Power Supply	28
A.4.6	Dimensions and weight	28
A.4.7	Environmental Specifications.	29
Appendix B	Radio Information.	30

B.1 WWAN Specifications 30

I Related Documents

Teldat Dm748-I Software Updating

Chapter 1 About This Guide

This is the installation guide for the **Teldat 4Ge** router. It contains information on how to correctly install the device in a working environment.

1.1 Supported Devices

The information included in this installation guide only applies to the **Teldat 4Ge** router.

1.2 Who should read this manual?

This manual should be read by the support personnel who need to configure, maintain and monitor the device.

1.3 When should this manual be read?

Read this guide as soon as you are ready to familiarize yourself with the device and its components.

This manual will help you understand your new device in greater depth.

1.4 What is in this manual?

This installation guide contains the following information:

- Description of the available features in the **Teldat 4Ge**.
- Technical specifications.
- Power supply requirements.
- Elements you can connect to the device while it is running.
- Installation and removal procedures for modules and power supplies.
- Description of the device LEDs and connectors.
- Troubleshooting.

1.5 What is not in this manual?

This manual does not contain information regarding the device software or its configuration. For information on how to configure this device, please see the relevant protocol manuals, to be found on the Teldat website: <http://www.teldat.com>.

1.6 How is the information organized?

Each chapter focuses on a specific part of the hardware and its components. All descriptive, technical specifications and information on a component can be found in the relevant chapter.

1.7 Technical Support

Teldat S.A. offers a technical support service. Device software can be upgraded on a regular basis for maintenance purposes and for new features.

Contact information:

Web: <http://www.teldat.com>

Tel.: +34 918 076 565

Fax: +34 918 076 566

Email: support@teldat.com

Chapter 2 Teldat 4Ge Router

2.1 Characteristics

2.1.1 Power Supply

For further information on **Teldat 4Ge**'s power supply, please see [Components and Power Supply](#) on page 5 under section [Power Source](#) on page 11.

2.1.2 Hardware Monitoring

The **Teldat 4Ge** router hardware is monitored through the LED panel, which provides visual information on what is happening in the device. The LEDs indicate the state of the hardware components, whether there is connectivity or not, data flows, etc.

For further information on the LED panel, please see [Components](#) on page 5 in the following chapter.

Chapter 3 Components and Power Supply

The following chapter provides detailed information on the **Teldat 4Ge** router chassis and its components. This information includes:

- Components.
- Information on assembly.
- Power supply.
- RESET button.
- Data connection.
- SIM card installation.

3.1 Components

3.1.1 Front Panel

The following figure shows the front panel. Here you can see where to insert one of the WWAN antenna connectors and the SIM card slot.

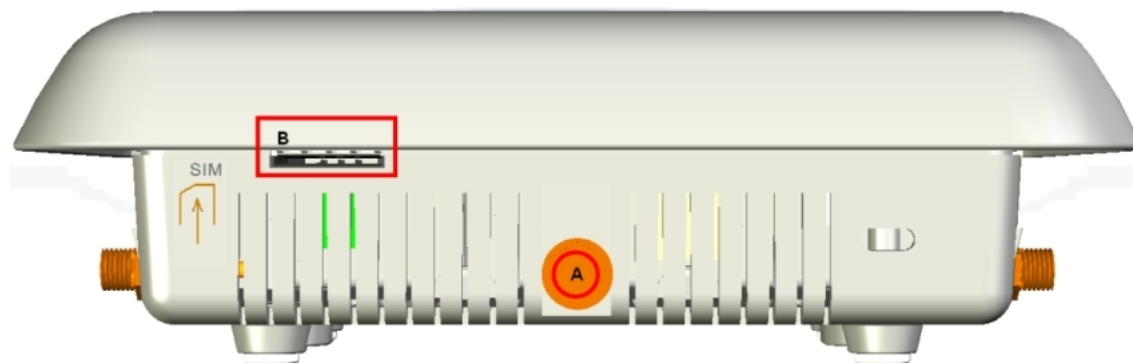

Fig. 1: Front Panel

The front panel elements are as follows:

Front panel elements table

Item	Description
A	WWAN antenna for the Teldat 4Ge .
B	SIM card slot.

3.1.2 Rear Panel

The following figure shows the rear panel. Here you can see all the **Teldat 4Ge** connectors.

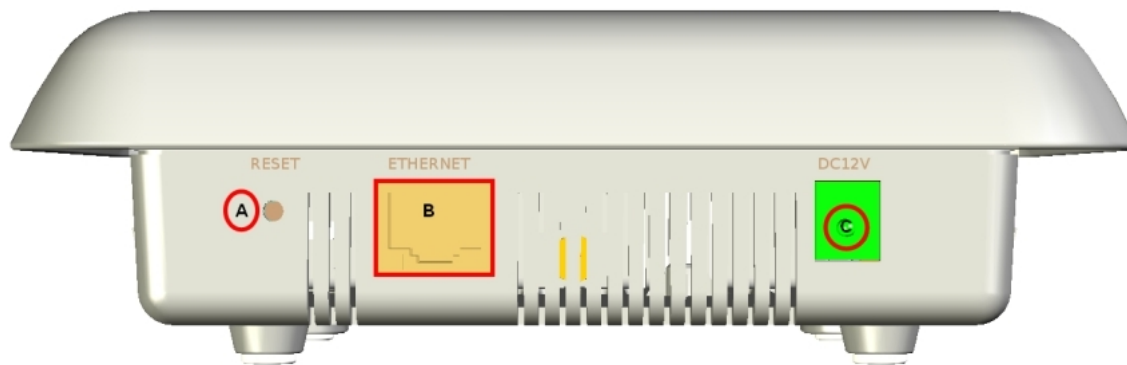

Fig. 2: Rear panel

The following table provides information on each connector, together with a description:

Rear panel elements table

Item	Description
A	RESET. Reset button. For further information on how the reset button works, please see RESET Button on page 13 in this chapter.
B	ETHERNET. Gigabit Ethernet.
C	Power source connection (PSU).

3.1.3 Side Panels

Two WWAN antennas are located on the side panels, one on either side.



Fig. 3: Right hand side panel and Fig. 4: Left hand side panel

3.1.4 Underside Panel

The following elements can be found on the underside panel:

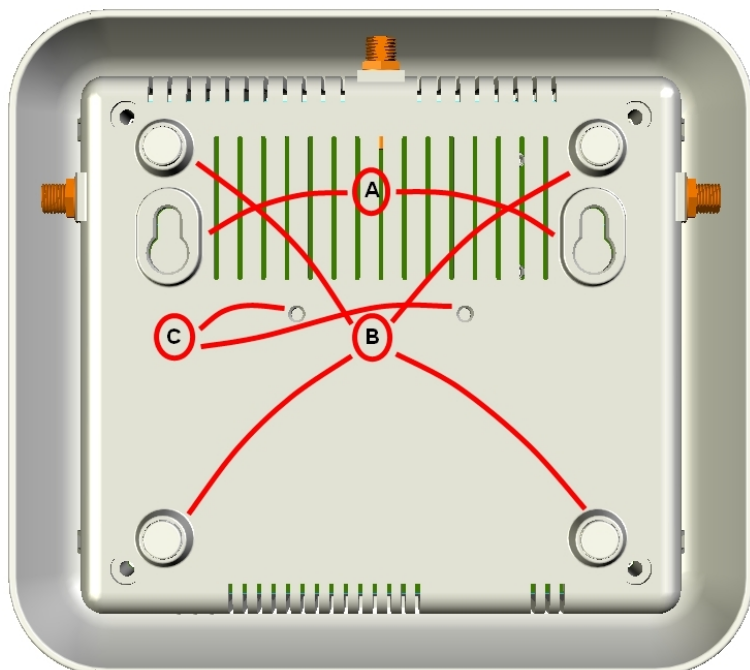

Fig. 4: Underside panel

The following table contains details on the underside panel's significant elements.

Underside panel elements table

Item	Description
A	Slots for wall mounting.
B	Rubber feet.
C	Perforations to install a DIN rail mount. (Optional.)

3.1.5 Top Panel (LEDs)

The LED panel provides information on the state of the components (whether they are active or not) and on network activity.

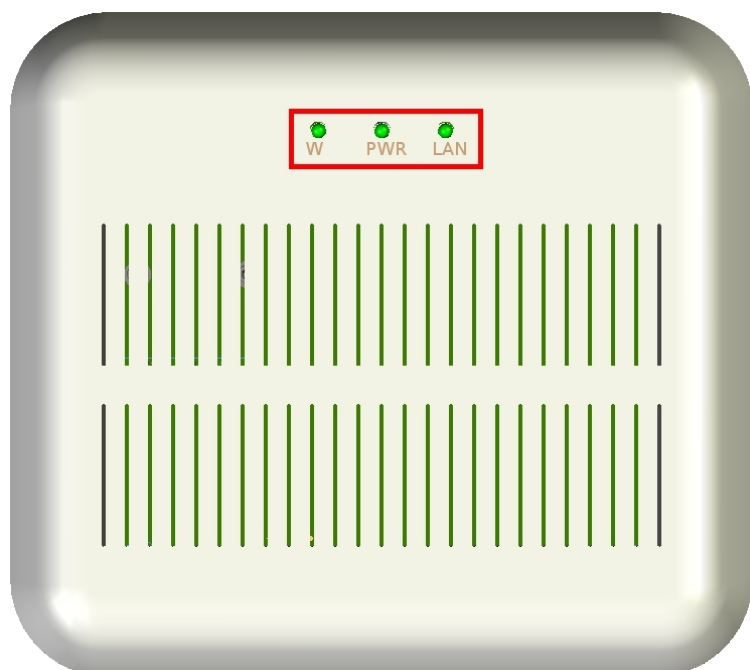

Fig. 5: LED Panel

The **Teldat 4Ge** LEDs are shown in Figure 6. The table below contains a description of each:

LEDs table

LED	Status	Description
LAN	Tricolor	Green -> connected. Blinking: connection data activity. Amber -> blinking: auto-test. Red -> disconnected.
PWR	Monochrome green	Device ON/OFF. This lights up when connected to the power source.
W	Tricolor	Off -> system stopped. Red -> interface unavailable because it is installing, not enabled (shutdown) or due to auto-test failure. Yellow -> idle. <ul style="list-style-type: none"> • Rapid blinking. It has not registered in the network or the quality is insufficient. • Slow blinking. GSM connection (GPRS). • Steady. WCDMA (UMTS/HSDPA) connection. Green -> connected. Blinking: connection data activity.

3.2 Assembly

3.2.1 Mounting in rack

The **Teldat 4Ge** cannot be mounted in a rack. However, there are other types of mounting.

3.2.2 Standalone

The **Teldat 4Ge** can be placed as a standalone device on a flat, stable surface.

Make sure there is enough space around the router for ventilation purposes and that electricity cables can reach it.

3.2.3 Wall mounting

The **Teldat 4Ge** can be mounted on the wall.

There are two slots on the underside of the device, used to fix it to the wall. You can see this in [Underside Panel](#) on page 6.

We recommend the following accessories for wall mounting, valid for solid and Gypsum board (plaster) walls:

- 2 screws: [Coach Screw Head 90 Degrees. 3.5x30].



Fig. 6: **Screw**

- 2 wall anchors: [White Striated Wall Anchor. 8mm Diameter].



Fig. 7: **Wall anchor**



Warning

The screws must go into a wall stud (wood) or a wall anchor of the appropriate type for the wall. Screws into drywall are not strong enough to mount the router.

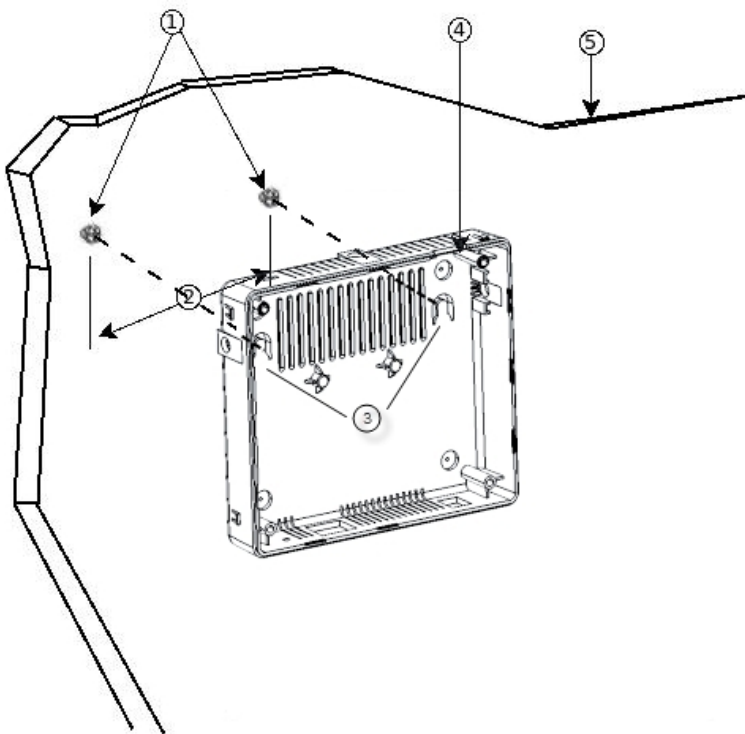

Fig. 8: **Wall-mounting features**

The above figure shows the wall-mounting features on the **Teldat 4Ge**.

1	Wall screws	2	8.8 cm (3.46 inches)
3	Chassis mounting holes (on the underside)	4	Router chassis
5	Mounting surface		

To mount the router on a wall or another surface, follow these steps:

Procedure

Step 1 Install the two screws (3.5x30) horizontally apart on a wall or any other vertical surface.

The screws should protrude 0.6 cm (0.25 inch) from the surface of the wall.



Warning

If you install the screws in drywall, use hollow-wall anchors (8 mm – 5/16 inch) to secure the screws. If the screws are not properly anchored, the strain of the cables connected to the router back panel could pull the router from the wall.

Step 2 Hang the router on the screws. This is the appropriate position for safe use. (See [Fig. 8](#) on page 9)



Note

- Wall mounting accessories are not provided and must be acquired separately.
- The accessories must match the kind of wall in place and support the weight of the device.

3.2.4 Ceiling mounting

To attach the **Teldat 4Ge** device to the ceiling, use the appropriate support (not included and must be ordered separately).

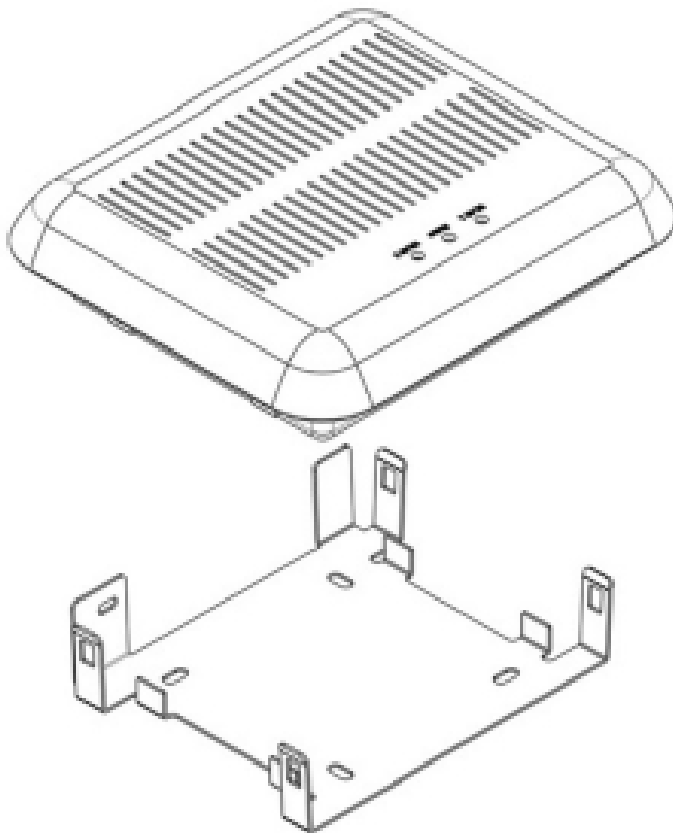

Fig. 9: Ceiling mounting support

3.2.5 Installing a DIN rail mount accessory (Optional)

Router packaging may contain a DIN rail mount kit, which can be attached to the router to place it in various positions.

The kit contains 2 screws to adjust the rail accessory on the underside of the device, as shown in the following figure:

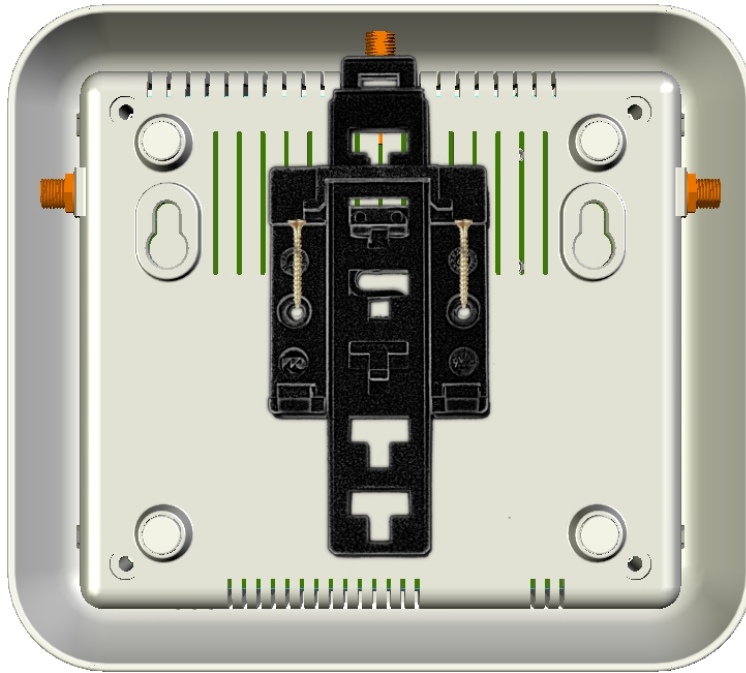

Fig. 10: DIN rail mount adapter

3.3 Power Source

The **Teldat 4Ge** is powered through an external AC/DC source or through an Ethernet cable (provided it complies with the POE 802.3af standard).



Warning

The equipment must be used with the power supply provided by the manufacturer.

Workplace Conditions. Main Characteristics

- Avoid humid and/or dusty locations.
- Direct exposure to sunlight and to other heat sources should be avoided. The device should not be placed amongst papers, magazines or other elements that could hinder natural air circulation.
- The device should not be placed near strong electromagnetic fields such as speakers, engines, etc.
- Knocks and/or strong vibrations should be avoided during transport, operation and storage.



Warning

The electric current in power cables, telephone lines and communication cables is dangerous. To prevent electric shocks, before installing, handling or opening the equipment covers, connect and disconnect the cables following the steps set forth in [Connect](#) on page 12 and [Disconnect](#) on page 13.

3.3.1 External Power Source

To connect the power supply to the device, please follow the steps outlined in [If the Ethernet cable isn't PoE](#) on page 12.

To avoid electric shocks, residual current circulation, and other unwanted effects that also affect communications, the following is recommended:



Warning

All interconnected communication devices should be plugged to THE SAME GROUNDED POWER OUTLET, which should at the same time be of good quality (lower than 10 ohms).

Whether the workplace is provided with an uninterrupted power supply system (UPS), regulated supply or it is independent from the rest (such as lighting, etc.); it is highly recommended that all data devices should be connected to the same power source. This will avoid operating and premature aging problems of drivers and other components.

3.3.2 PoE

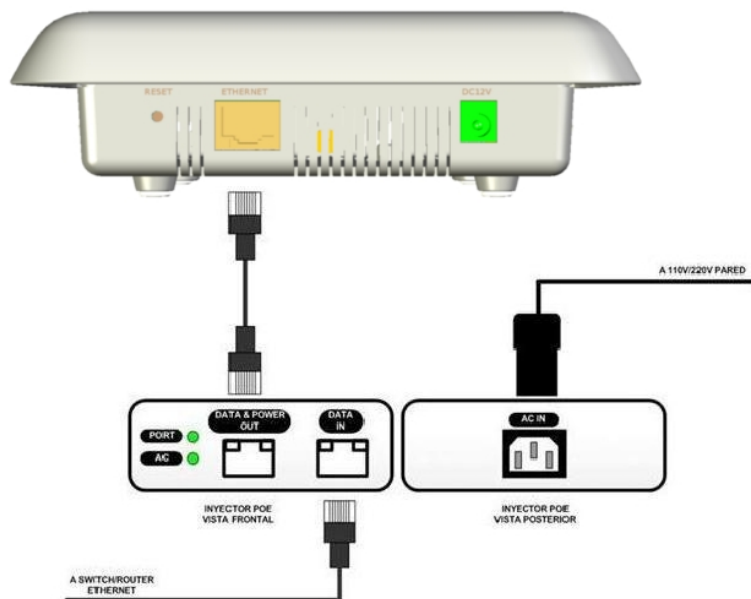

Fig. 11: Connecting the PoE adapter to the router

The **Teldat 4Ge** device can be powered through an Ethernet cable, provided the latter complies with the POE 802.3aF standard. The ETHERNET port is enabled for this.

To connect the Ethernet cable with PoE power to the router, please carry out the steps outlined in [If the Ethernet cable is PoE](#) on page 13.

Figure 11 details how to connect the PoE injector to the device.

Teldat S.A. offers an optional PowerDsine PD-3501G/AC PoE injector as an accessory. Please contact your dealer for more information

3.3.3 Connecting to the power source

3.3.4 Connect

3.3.4.1 If the Ethernet cable isn't PoE

- Make sure the router's power switch is in the OFF position (0).
- Make sure the power supply is NOT connected to either the electricity or the router.
- Connect all data cables.
- Connect the power cable to the device.
- Connect the power cable to the electricity supply.
- Set the router's power switch to the ON position (1).

3.3.4.2 If the Ethernet cable is PoE

- Check that the Ethernet cable that is going to be used for power is NOT connected to the router.
- Make sure the router's power switch is in the OFF position (0).
- Make sure the power supply is NOT connected to the electricity supply.
- Connect all data cables.
- If you need redundant power, connect the power supply to the device.
- If you need redundant power, connect the power supply to the electricity supply.
- Connect the Ethernet cable.
- Set the router's power switch to the ON position (1).

3.3.5 Disconnect

3.3.5.1 If the Ethernet cable isn't PoE

- Make sure the router's power switch is in the OFF position (0).
- Disconnect the power supply from the electricity supply.
- Disconnect the power supply from the router.
- Disconnect the data cables.

3.3.5.2 If the Ethernet cable is PoE

- Disconnect the Ethernet cable.
- Make sure the router's power switch is in the OFF position (0).
- Disconnect the power supply from the electricity supply.
- Disconnect the data cables.

3.4 RESET Button

The different features of the RST button are described below.

3.4.1 Rebooting the device

Once the device is operating normally, if you press the RST button, it will restart.

3.4.2 Default Configuration

The RST button allows you to boot the device with its default configuration through the following steps:

- With the device switched off, maintain the RESET button pressed and it will switch on.
- The POWER LED (green) will light up and the W LED will begin to blink. This blinking will continue for 10 seconds.
- For the device to boot with the default configuration, release the RESET button while the W LED is blinking (i.e. before the 10 second period expires).

Once the default configuration is running, you need to know what type of license the device has. Depending on the license, the device will operate as:

- Router: If you have a router license, the device will behave as a router. In this case, the default configuration establishes the following access IP address and mask:

IP address: 192.168.1.1

IP mask: 255.255.255.0

- 4Ge: If you have a 4Ge license, the device will have a special configuration. Please see manual Teldat Dm592-I -

Teldat 4Ge User Manual for further information on how to access the device and its configuration.

To find out what type of license you have, execute a ping to IP address 192.168.1.1. The device, previously configured with the default configuration and correctly connected through an Ethernet cable, will respond to the ping indicating whether you are dealing with a router or a 4Ge.



Note

Some devices leave the factory with customized settings. As a result of this personalization, the device may have a different default configuration from the one shown above.

3.5 Connecting data

The **Teldat 4Ge** has the following data connections.

3.5.1 ETHERNET Connection

The **Teldat 4Ge** incorporates an Ethernet 10/100/1000 BaseT Switch port with automatic MDI/MDIX.

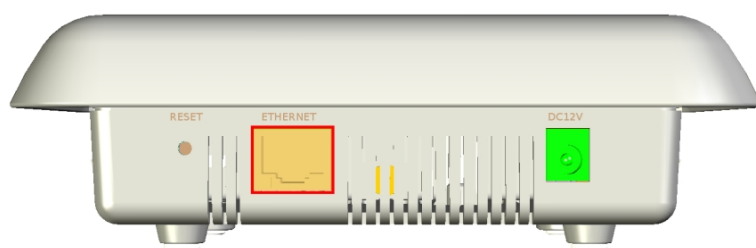

Fig. 12: Ethernet Port

3.5.2 Connecting the WWAN Antenna

The **Teldat 4Ge** has three connectors for WWAN antennas. To assemble and disassemble the antennas, simply screw them into the connectors labeled *Cell* (found in the router's front panel).

Installing these antennas in the **Teldat 4Ge** is essential to improve the quality of the signal received and transmitted by the cellular model.



Note

To achieve good quality performance, the **Teldat 4Ge** device should always have the WWAN antennas installed.

Some cellular telephony technologies use the antenna diversity technique to improve the quality of the signal received (HSUPA, CDMA EV-DO, etc.). Consequently, the **Teldat 4Ge** incorporates various WWAN connectors.

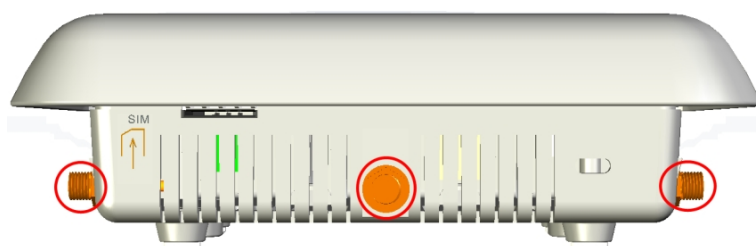

Fig. 13: WWAN connectors seen from the front panel

When the antennas are not directly connected to the router but installed through extension cords, the minimum distance between the two of them must be 7 cm. The maximum recommended distance between the two is 25 cm.

To achieve optimum performance, the radio frequency accessories installed (antennas and cables) should be those recommended by Teldat.

Teldat has a series of accessories (90° mount antennas, antennas for exterior installation, antennas for ceiling installation, extension cables, etc.) that allow you to install the devices in different locations.

3.5.2.1 Placing the Antenna

The orientation of the **Teldat 4Ge** device and its location with respect to other wireless and radiation devices (such as communication devices, personal computers, etc.) can significantly influence performance.

The **Teldat 4Ge** device transmits and receives. Performance is also affected by environmental factors (such as distance between the device and the base station), physical obstacles and other interferences caused by radiofrequencies (RF).

For optimum coverage, follow these steps:

- Whenever possible, place the antenna where there are no physical obstacles. Obstacles between the antenna and the base station degrade the wireless signal. Place the antenna above ground level and facing the nearest base station.
- The density of materials also affects antennas. Place them away from walls, metal screens, mirrors, etc.
- Do not place the antenna near columns, which may throw shadows and reduce the coverage area.
- Keep the antenna away from metal ducts such as canalization, air-conditioning.
- Please bear in mind that other wireless devices such as telephones, microwaves, etc., can temporarily interfere with the quality of the radio signal.
- We do not recommend installing antennas near, or between, racks containing communication devices, computers, etc. Use an extension cable and place the device outside.

The following recommendations are applicable to all wireless devices:

- Do not touch or move the antenna while the device is transmitting or receiving.
- When the antenna is transmitting, do not touch any equipment that contains devices that radiate very close to, or touching, any exposed part of the body (particularly face and eyes).
- Do not install the device in areas where the atmosphere is potentially explosive.
- Wireless devices can cause interferences with other devices. Do not use the device in environments where medical equipment is installed.
- To ensure compliance with the R&TTE 1999/5/EC standard, the device must be at least 1.5 cm away from a human body when operating.

3.6 Installing the SIM card

A SIM card needs to be inserted in the **Teldat 4Ge** so the WWAN interface operates correctly. The router is equipped with an external SIM card tray.

When inserting the SIM card, make sure you are protected against electrostatic discharges (ESD).



Warning
Do not touch the SIM card connector.

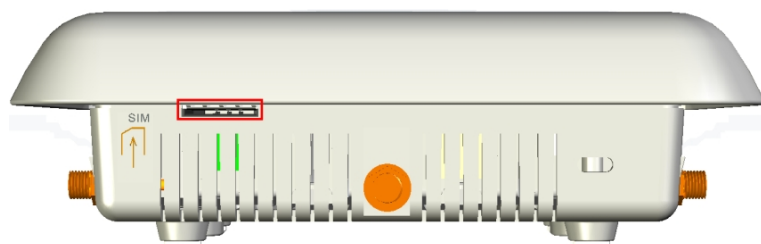

Fig. 14: Slot to insert the SIM card

Procedure:



- Place the router as shown in the figure above.
- To insert the SIM card, follow the instructions shown on the **Teldat 4Ge**.
- Press it until it is fully inserted.
- To extract it, press it again and remove it.

Chapter 4 Compliance



4.1 Manufacturer information

<i>Brand</i>	Teldat
<i>Manufacturer</i>	Teldat S.A.
<i>Country</i>	Spain
<i>Postal Address</i>	Isacc Newton, 10 Parque Tecnológico de Madrid, 28760 Tres Cantos, Madrid, Spain
<i>International Phone</i>	+34 91 807 65 65

4.2 Safety Warnings

	<p>The electric current in power cables, telephone lines and communication cables is dangerous. To prevent electric shocks, before installing, handling or opening the equipment covers, connect and disconnect the cables following the steps set forth in Connect on page 12 and Disconnect on page 13.</p>
	<p>Электрический ток в кабелях и проводах может быть опасен для жизни и здоровья. Чтобы предотвратить поражение током, перед установкой оборудования, его обслуживанием и снятием панелей необходимо отсоединять кабели в соответствии с правилами, изложенными в соответствующем разделе.</p>
	<p>Le courant électrique qui circule dans les câbles d'alimentation, les lignes téléphoniques et les câbles de communication est dangereux. Afin d'éviter tout choc électrique, brancher, puis débrancher les câbles en suivant les consignes préconisées dans chaque section avant d'installer, de manipuler ou d'ouvrir les caches de l'équipement.</p>
	<p>Der elektrische Strom in Strom-, Telefon- und Datenkabeln ist gefährlich. Um Elektroschocks zu vermeiden, trennen Sie vor der Installation, der Bedienung oder dem Öffnen des Geräts die Kabel wie in den Abschnitten Verbinden und Trennen beschrieben.</p>
	<p>La tensión eléctrica de los cables de alimentación, de los cables de la línea telefónica y de los cables de comunicación es peligrosa. Para evitar descargas, antes de instalar, mover o abrir las cubiertas de este equipo, conecte y desconecte los cables siguiendo el orden que se detalla en los apartados "Conectar" y "Desconectar".</p>
	<p>All interconnected communication devices should be plugged to THE SAME GROUNDED POWER OUTLET, which should at the same time be of good quality (lower than 10 ohms).</p> <p>Whether the workplace is provided with an uninterrupted power supply system (UPS), regulated supply or it is independent from the rest (such as lighting, etc.); it is highly recommended that all data devices should be connected to the same power source. This will avoid operating and premature aging problems of drivers and other components.</p>
	<p>Убедитесь в том, что все связанные устройства связи подключены к ОДНОЙ И ТУ ЖЕ ЗАЗЕМЛЕННОЙ ШТЕПСЕЛЬНОЙ РОЗЕТКЕ высокого качества (сопротивление не превышает 10 Ом).</p>
	<p>Проверьте, оборудовано ли рабочее место источником бесперебойного питания (ИБП), источником регулируемого питания, или оно является независимым от других систем (таким как освещение и т.п.); строго рекомендуется подключать все информационные устройства к одному источнику питания. Это поможет предотвратить эксплуатационные проблемы и преждевременное старение приводов и других деталей.</p>
	<p>Tous les dispositifs de communications interconnectés doivent être branchés sur la même prise correctement mise à la terre, qui doit être de bonne qualité (moins de 10 ohms).</p> <p>Soit le lieu de travail équipé d'un système d'alimentation sans interruption (ASI), alimentation régulée ou indépendante du reste (comme l'éclairage, etc), il est fortement recommandé que tous les dispositifs de données soient reliés à la même source d'alimentation. Cela permettra d'éviter des problèmes de fonctionnement et de vieillissement prématuré de drivers et d'autres composants.</p>
	<p>Alle miteinander verbundenen Kommunikationsgeräte sollten mit der gleichen geerdeten</p>

	<p>Stromversorgung verbunden werden. Diese sollte von hoher Qualität sein (niedriger als 10 Ohm).</p> <p>Unabhängig davon, ob der Arbeitsplatz über eine unterbrechungsfreie Stromversorgung (UPS) oder eine geregelte Versorgung verfügt oder unabhängig von der weiteren Installation (z. B. Licht) ist – es wird dringend empfohlen, alle Geräte an die gleiche Spannungsversorgung anzuschließen. Dies beugt Problemen im Betrieb sowie Problemen der vorzeitigen Alterung von Komponenten vor.</p>
	<p>Todos los equipos de comunicaciones interconectados deberán estar unidos a UNA MISMA TOMA DE TIERRA, a ser posible de buena calidad (inferior a 10 ohmios).</p> <p>Si la instalación está dotada de un Sistema de Alimentación Ininterrumpida (SAI), alimentación estabilizada, o bien es independiente del resto (alumbrado, etc.), conecte todos los equipos de comunicaciones a la misma fuente de alimentación. Así, se ahorrará problemas de funcionamiento y envejecimiento prematuro de drivers y demás componentes.</p>
	<p>Never install the SIM cards when the device is switched on.</p> <p>Always disconnect the device from the main power supply before installing the SIM cards.</p> <p>Always disconnect the device before removing the casing to access the trays.</p> <p>When inserting the SIM cards, please protect yourself against electrostatic discharges (ESD).</p> <p>Do not touch the SIM card connectors.</p>
	<p>Никогда не устанавливайте SIM-карты, когда устройство включено.</p> <p>Перед установкой SIM-карт отключите устройство от источника питания.</p> <p>Всегда отключайте устройство перед тем, как снять корпус и извлечь лотки.</p> <p>При установке SIM-карты, пожалуйста, защитите себя от электростатических разрядов (ESD).</p> <p>Не прикасайтесь к контактам SIM-карты.</p>
	<p>N'installez jamais la carte SIM lorsque l'appareil est allumé.</p> <p>Débranchez toujours l'appareil de l'alimentation électrique principale avant d'insérer les cartes SIM.</p> <p>Débranchez toujours l'appareil avant de retirer le boîtier pour accéder aux baies.</p> <p>Lors de l'insertion de la carte SIM, protégez-vous contre les décharges électrostatiques (ESD).</p> <p>Ne touchez pas les connecteurs des cartes SIM.</p>
	<p>Installieren Sie keine SIM-Karten, solange das Gerät eingeschaltet ist.</p> <p>Trennen Sie das Gerät immer von der Stromversorgung, bevor Sie eine SIM-Karte installieren.</p> <p>Trennen Sie das Gerät immer von der Stromversorgung, bevor Sie das Gehäuse für einen Zugang zu den SIM-Halterungen öffnen.</p> <p>Berühren Sie die SIM-Karten-Kontakte nicht.</p> <p>Schützen Sie sich gegen elektrostatische Entladung (ESD), wenn Sie eine SIM-Karte installieren.</p>

	<p>No instale nunca las tarjetas SIM con el equipo encendido.</p> <p>Desconecte siempre el equipo de la red antes de instalar las tarjetas SIM.</p> <p>Desconecte siempre el equipo antes de desmontar la carcasa para acceder a las bandejas.</p> <p>Al insertar las tarjetas SIM, protéjase contra descargas electroestáticas (ESD).</p> <p>No toque los conectores de las tarjetas SIM.</p>
	<p>The equipment is intended to be installed by Service Personnel and only handled by qualified personnel. If not, the device may be damaged and malfunction.</p>
	<p>Оборудование должно эксплуатироваться квалифицированным персоналом; в противном случае устройство может быть повреждено и впоследствии работать неисправно.</p>
	<p>L'équipement est destiné à être installé par le Personnel de Service et seulement manipulé par du personnel qualifié. Sinon, l'appareil risque d'être endommagé et dysfonctionner.</p>
	<p>Das Gerät ist für eine Montage durch Servicepersonal ausgelegt und darf nur von qualifiziertem Personal gehandhabt werden. Andernfalls kann es zur Beschädigung des Geräts und zu Fehlfunktionen kommen.</p>
	<p>El equipo está diseñado para ser instalado por personal del servicio técnico y su manejo debe realizarlo personal cualificado. De lo contrario, el equipo puede resultar dañado y quedar inservible.</p>
	<p>The equipment must be used with the power supply provided by the manufacturer.</p>
	<p>Оборудование должно использоваться с источником питания поставляемым производителем.</p>
	<p>L'équipement doit être utilisé avec la source d'alimentation fournie par le fabricant.</p>
	<p>Das Gerät muss mit dem vom Hersteller gelieferten Netzteil betrieben werden.</p>
	<p>El equipo debe ser usado con la fuente de alimentación proporcionada por el fabricante.</p>
	<p>The screws must go into a wall stud (wood) or a wall anchor of the appropriate type for the wall. Screws into drywall are not strong enough to mount the router.</p>
	<p>Болты должны входить в стойки каркаса в стенах (деревянные) или стеновые анкеры соответствующего типа. Завинчивание болтов в гипсокартон не является достаточно надежным для монтажа маршрутизатора.</p>
	<p>Les vis doivent aller dans un poteau mural (bois) ou un ancrage murau du type approprié. Vis en plaques de plâtre ne sont pas assez forts pour monter le routeur.</p>

	Die Schrauben müssen in einen Dübel oder Wandanker geschraubt werden, der für die jeweilige Art der Wand geeignet ist. Schrauben in einer Trockenbauwand sind nicht stabil genug, um den Router zu halten.
	Los tornillos deben ir atornillados en un taco de pared (de madera) o del tipo adecuado según la clase de pared. Los tornillos que se montan directamente en los paneles de yeso no son lo bastante resistentes para soportar el router.
	If you install the screws in drywall, use hollow-wall anchors (8 mm – 5/16 inch) to secure the screws. If the screws are not properly anchored, the strain of the cables connected to the router back panel could pull the router from the wall.
	Если вы установите винты в гипсокартона , используйте полым дюбели (8мм - 5/16 дюйма) , чтобы обеспечить винты. Если винты крепления закручены недостаточно плотно, маршрутизатор может упасть со стены из-за натяжения подключенных к нему кабелей.
	Si vous installez les vis dans des cloisons sèches, utilisez des ancrs creuses-murales (8 mm - 5/16 po) pour fixer les vis. Si les vis ne sont pas fixées correctement, la tension des câbles raccordés au panneau arrière du routeur pourrait tirer le routeur de la paroi.
	Wenn Sie die Schrauben in eine Trockenbauwand schrauben wollen, verwenden Sie Hohlraumdübel (8 mm – 5/16 Zoll), um die Schrauben zu sichern. Wenn die Schrauben nicht angemessen verankert sind, kann Zug auf die Verkabelung an der Rückseite des Routers diesen aus der Wand reißen.
	Si instala los tornillos en paneles de yeso, utilice tacos de pared hueca (8 mm - 5/16 pulgadas) para fijar los tornillos. Si los tornillos no están bien anclados, la tensión de los cables conectados al panel posterior del router podría hacer que el router se cayera de la pared.

4.3 WEEE Information



The waste container symbol with the >X< indicates that the device must be disposed of separately from normal domestic waste at an appropriate waste disposal facility at the end of its useful service life.

Das auf dem Gerät befindliche Symbol mit dem durchgekreuzten Müllcontainer bedeutet, dass das Gerät am Ende der Nutzungsdauer bei den hierfür vorgesehenen Entsorgungsstellen getrennt vom normalen Hausmüll zu entsorgen ist.

El símbolo del contenedor con la cruz, que se encuentra en el aparato, significa que cuando el equipo haya llegado al final de su vida útil, deberá ser llevado a los centros de recogida previstos, y que su tratamiento debe estar separado del de los residuos urbanos.

4.4 REACH

In compliance with the REACH Candidate List, the delivered product and product packaging do not contain chemical substances above a concentration limit of 0.1% weight by weight (w/w). This declaration will be updated whenever any changes occur or other chemical substances are added to the REACH Candidate List. Information is currently provided to consumers upon request.

4.5 PSU Energy Efficiency

According to Commission Regulation (EU) 2019/1782 laying down ecodesign requirements for external power supplies pursuant to Directive 2009/125/EC of the European Parliament and of the Council and repealing Commission Regulation (EC) No 278/2009, the instruction manuals for end-users shall include the following information:

<i>Model</i>	WA-12M12R
<i>Manufacturer Name</i>	ASIAN POWER DEVICES INC. (APD)
<i>Manufacturer Address</i>	NO.5 LANE 83. LUNG-SOU ST, TAO-YUAN CITY, TAIWAN R.O.C.
<i>Input Voltage</i>	100-240 Vac
<i>Input AC frequency</i>	50-60 Hz
<i>Output voltage</i>	12.0 V
<i>Output current</i>	1.0 A
<i>Output power</i>	12.0 W
<i>Average active efficiency</i>	83.6 %
<i>Efficiency at low load (10%)</i>	73.8 %
<i>No-load power consumption</i>	0.09 W
<i>Model</i>	WB-12G12R
<i>Manufacturer Name</i>	ASIAN POWER DEVICES INC. (APD)
<i>Manufacturer Address</i>	NO.5 LANE 83. LUNG-SOU ST, TAO-YUAN CITY, TAIWAN R.O.C.
<i>Input Voltage</i>	100-240 Vac
<i>Input AC frequency</i>	50-60 Hz
<i>Output voltage</i>	12.0 V
<i>Output current</i>	1.0 A
<i>Output power</i>	12.0 W
<i>Average active efficiency</i>	83.4 %
<i>Efficiency at low load (10%)</i>	80.0 %
<i>No-load power consumption</i>	0.07 W
<i>Model</i>	WA-36N12R
<i>Manufacturer Name</i>	ASIAN POWER DEVICES INC. (APD)
<i>Manufacturer Address</i>	NO.5 LANE 83. LUNG-SOU ST, TAO-YUAN CITY, TAIWAN R.O.C.
<i>Input Voltage</i>	100-240 Vac

<i>Input AC frequency</i>	50-60 Hz
<i>Output voltage</i>	12.0 V
<i>Output current</i>	3.0 A
<i>Output power</i>	36.0 W
<i>Average active efficiency</i>	87.403 %
<i>Efficiency at low load (10%)</i>	78.3 %
<i>No-load power consumption</i>	Lower than 0.1 W

4.6 EC Declaration of Conformity

English (EN)	<p>Hereby, Teldat S.A. declares that the Teldat 4Ge radio equipment is in compliance with:</p> <p>Directive 1999/5/EC (until 12 June 2017) and Directive 2014/53/EU (from 13 June 2017)</p> <p>Directive 2009/125/EC (ErP)</p> <p>Directive 2011/65/EU (RoHS)</p> <p>of the European Parliament.</p>
Spanish (ES) Español	<p>Por la presente, Teldat S.A. declara que el tipo de equipo radioeléctrico Teldat 4Ge es conforme con:</p> <p>Directiva 1999/5/EC (hasta el 12 de junio de 2017) y Directiva 2014/53/EU (desde el 13 de junio 2017)</p> <p>Directiva 2009/125/EC (ErP)</p> <p>Directiva 2011/65/UE (RoHS)</p> <p>del Parlamento Europeo</p>

The EC declaration of conformity and additional product documentation can be accessed here:

<http://www.teldat.com/conformity>

4.7 CE Marking

This equipment is in conformity with the CE procedures and marking.



4.8 National Restrictions

In accordance with article 10 of Directive 2014/53/EU, we inform you that (for authorization purposes) there may be national restrictions and requirements. Country-specific requirements may evolve over time. Teldat S.A. recommends that you check with local authorities for the latest status of their national regulations.

This product is supplied with antennas in order to fulfill the local regulation. Do not choose other antennas. To comply with power limits and RF exposure requirements, the antennas used for this transmitter must be installed so that

people keep a separation distance of, at least, 20 cm.

4.9 Operating Frequency

To check the device's operating frequencies, see Appendix [WWAN Specifications](#) on page 30.

4.10 FCC Statement

4.10.1 Federal Communications Commission Interference

This equipment has been tested and found to comply with the limits for a Class B digital device, pursuant to Part 15 of the FCC Rules. These limits are designed to provide reasonable protection against harmful interference in a residential installation.

This equipment generates, uses and can radiate radio frequency energy and, if not installed and used in accordance with the instructions, may cause harmful interference to radio communications. However, there is no guarantee that interference will not occur in a particular installation. If this equipment does cause harmful interference to radio or television reception (determined by turning the equipment off and on), the user is encouraged to try to correct the interference through one of the following means:

- Reorient or relocate the receiving antenna.
- Increase the separation between the equipment and the receiver.
- Connect the equipment to an outlet on a circuit that is different from the one used by the receiver.
- Contact the dealer, or an experienced radio/TV technician, for help.

Any changes or modifications not expressly approved by the party responsible for compliance could void the user's permission to operate this equipment.

This device complies with Part 15 of the FCC Rules. Operation is subject to the following two conditions: (1) this device may not cause harmful interference, and (2) this device must accept any interference received, including interference that may cause undesired operation.

This device and its antennas(s) must not be placed or operated in conjunction with any other antenna or transmitter, except when done in accordance with FCC multi-transmitter product procedures.

4.11 IC Statement

4.11.1 CAN ICES-3 (B)/NMB-3(B)

This device complies with Industry Canada license-exempt RSS standard(s). Operation is subject to the following two conditions: (1) this device may not cause interference, and (2) this device must accept any interference, including interference that may cause undesired operation of the device.

Le présent appareil est conforme aux CNR d'Industrie Canada applicables aux appareils radio exempts de licence. L'exploitation est autorisée aux deux conditions suivantes: (1) l'appareil ne doit pas produire de brouillage, et (2) l'utilisateur de l'appareil doit accepter tout brouillage radioélectrique subi, même si le brouillage est susceptible d'en compromettre le fonctionnement.

This device and its antennas(s) must not be placed or operated in conjunction with any other antenna or transmitter, except when done in accordance with IC multi-transmitter product procedures.

Cet appareil et son antenne (s) ne doit pas être co-localisés ou fonctionner en association avec une autre antenne ou transmetteur.

Appendix A Technical Information

A.1 Troubleshooting

The following table can help solve problems when installing the device. If you cannot solve an issue, contact your dealer for more information.

Symptom	Solution
No LED lights up on the router.	Check the power supply to the router (power source, ON/OFF switch, main power outlet).
You have forgotten the router's access password.	Ignore the configuration through the RESET button (as explained in the relevant section).
The LAN LED never lights up in green.	Check the Ethernet cable and the connection to the network.
The W LED never lights up in green.	Check the router's configuration and that of the remote station(s). Check the appropriate license is available for use.
You cannot connect to the device after updating the software.	A failure in the uploading process may have damaged the current system software. The device will then start up with special software and configuration modes. You may access the device through IP address 192.168.1.1 and use FTP to restart the uploading process inserting <i>root</i> as the username and no password. Remember to configure the IP address of your computer so that it matches the subnet of the router.

A.2 Updating the software

The **Teldat 4Ge** can be updated to new releases. Please contact your distributor for further details on new releases.

Firmware updating is carried out through a traditional FTP file transfer. For further information on updating firmware through FTP, please see manual Teldat-Dm748-I Software Updating, section 1.3 *FTP Updating*.

To connect to the device through FTP, you need to use a username (*monitor*) and password (*teldat*).

```

imuno@imuno-ub:~$ ftp 192.168.1.1
Connected to 192.168.1.1.
220 FTP server ready, 1 active clients of 1 simultaneous clients allowed.
Name (192.168.1.1): monitor
331 User name accepted, need password.
Password:
230 User login complete.
Remote system type is UNIX.
ftp>

```

A.3 Connectors

A.3.1 LAN Connector

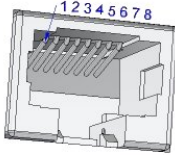
RJ45 LAN	RJ45 PIN	FE Signals	GE Signals	PoE Signals
	1	BI-DA+	BI-DA+	POE+(A)
	2	BI-DA-	BI-DA-	POE+(A)
	3	BI-DB+	BI-DB+	POE-(A)
	4	--	BI-DC+	POE+(B)
	5	--	BI-DC-	POE+(B)
	6	BI-DB-	BI-DB-	POE-(A)
	7	--	BI-DD+	POE-(B)
	8	--	BI-DD-	POE-(B)

A.3.2 WWAN Connector (female)

	PIN	ANT
	Internal	RF in/out
	External	GND

A.3.3 Power Supply Connector

PIN	ANT
Internal	POSITIVE
External	NEGATIVE

A.4 Technical Specifications

A.4.1 Hardware Architecture

PROCESSORS	Freescale P1014.
MEMORY	DDR3 1Gbit (128 MBytes).
STORAGE UNIT	FLASH Memory 128 Mbits (16 Mbytes).

A.4.2 LAN Interface

PROTOCOLS	Ethernet (802.3).
PORTS	Port managed with MDI/MDX autodetection.
SPEED	10/100/1000 Mbps (BaseT).
CONNECTOR	RJ45 female.

A.4.3 Wireless WAN Interface

STANDARDS	GPRS, UMTS, HSDPA, HSUPA, HSPA+, LTE ... Depends on the router's Wireless WAN interface version.
SPEED	Depends on the router's Wireless WAN interface version. Please check the module manual.
CONNECTOR	Up to 3 RF SMA female.
ANTENNA	Depends on the type of Wireless WAN module. Please check the antenna catalog for cellular interfaces.

A.4.4 Power Supply

INPUT VOLTAGE	+12 V DC.
INPUT CURRENT	1000 mA.
JACK	5.5 mm.
INTERNAL PIN	2.5 mm.

A.4.5 External Power Supply

INPUT VOLTAGE	100-240 V AC.
INPUT CURRENT	1.0 A.
INPUT FREQUENCY	50-60 Hz.

A.4.6 Dimensions and weight

TYPE	Desktop or wall-mounted.
LENGTH x WIDTH x HEIGHT	145 x 160 x 50 mm.
WEIGHT	0.3 kg.

A.4.7 Environmental Specifications

TEMPERATURE	OPERATING NORMALLY: 0 °C to 45 °C STORED: -25 °C to 70 °C
RELATIVE HUMIDITY	On: 5 % to 90 %

Appendix B Radio Information

In accordance with Article 10(8) of the Radio Equipment Directive 2014/53/EU, the following tables provide information on frequency bands and RF transmit power levels:

B.1 WWAN Specifications

GSM / GPRS / EDGE (2G) capable models

Bands	Frequency Range	Transmitted power
EGSM (900)	Tx: 880–915 MHz	GMSK: Class 4, 33 dBm max. 8PSK: Class E2, 27 dBm max
DCS (1800)	Tx: 1710–1785 MHz	GMSK: Class 4, 33 dBm max. 8PSK: Class E2, 27 dBm max

WCDMA (3G, UMTS) capable models

Bands	Frequency Range	Transmitted power
Band 1 (2100)	Tx: 1920-1980 MHz	Class3, 24 dBm max
Band 8 (900)	Tx: 880–915 MHz	Class3, 24 dBm max

LTE (4G) capable models

Bands	Frequency Range	Transmitted power
Band 1 (2100)	Tx: 1920-1980 MHz	Class 3, 23 dBm max.
Band 3 (1800)	Tx: 1710–1785 MHz	Class 3, 23 dBm max.
Band 7 (2600)	Tx: 2500–2570 MHz	Class 3, 23 dBm max.
Band 20 (800)	Tx: 832–862 MHz	Class 3, 23 dBm max.

This product is supplied with YWX-6221SAX9-508 antennas. To comply with the regulations, do not pick others.